

SPACERS, EXPANSION JOINTS AND PROFILES

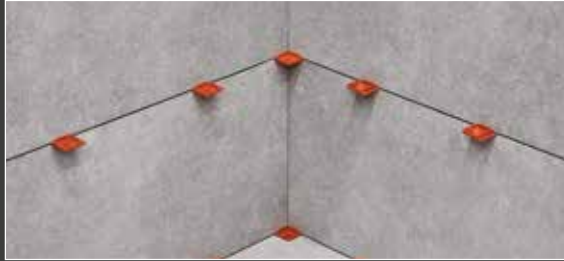

REMOVABLE AND REUSABLE DUAL SIZE (JOINT) SPACER

DOUBLE.....	R2
-------------	----

SPACERS FOR 20 mm THICKNESS TILES

SPACERS FOR 20 mm THICKNESS TILES	R3
---	----

3 IN-ONE TILE SHIM "ROTOCUNEO"

"ROTOCUNEO" FOR JOINTS FROM 2 mm UP TO 10 mm.....	R3
---	----

SPACERS FOR "+" AND "T" SETTING LAYOUT

10 mm	R4
9 mm	R4
8 mm	R4
7 mm	R4
6 mm	R5
5 mm	R5
4 mm	R5
3 mm	R6
2 mm	R6
1,5 mm	R6
1 mm	R6

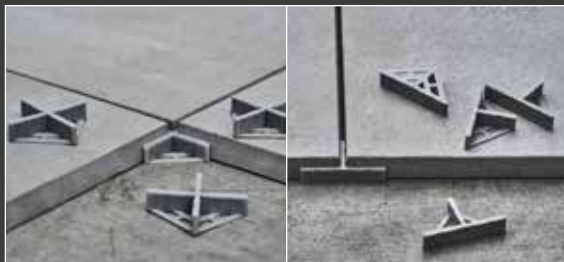

SPACERS FOR OCTAGONAL TILES, "CASSETTONATO"

AND LOZENGE, SPACERS FOR HEXAGONAL TILES,

SPACERS FOR PROVINCIAL - "PROVENZALE"

SPACERS FOR OCTAGONAL TILES, "CASSETTONATO" AND LOZENGE.....	R7
SPACERS FOR HEXAGONAL TILES	R7
SPACERS FOR PROVINCIAL - "PROVENZALE"	R7
SPACERS FOR SPECIAL FORMATS (RHOMBUS)	R7



WEDGES

BIG WEDGES	R7
SMALL WEDGES	R7

FLOATING FLOORS SUPPORTS

FLOATING FLOORS SUPPORTS	R7
--------------------------------	----



EXPANSION JOINTS AND PROFILES

EXPANSION JOINTS	R8
PVC TRANSITION PROFILES	R8

11 sizes (from 1 to 10 mm - 1/32" - 3/8") in 43 different models : here is our range of spacers. A line of spacers for the professional which can choose versions with different heights, with holes for the passage of the adhesive, with fins for easy removal or to avoid the outcrop if installing with the traditional "mud-med" method, or even with the unique "Lego" system, which allows to fit a spacer over the other to get the desired thickness. Of course, both for cross and "T" installation. In addition, three models (3 mm - 1/8" joint) for octagonal tile, "cassettonato", lozenge, hexagonal tiles, "provenzale" tiles and two models (2 mm - 3/32" joint) for special formats (rhombus). To complete the offer, shimming wedges are available in two sizes and "Rotocuneo", the new 3-in-one tile shim for adjustments from 2 mm (3/32") up to 10 mm (3/8"). Also expansion joints, profiles and floating floors supports and the new spacers designed for the laying of tiles with high thickness (20 mm - 3/4"), whose characteristics make them ideal for outdoor floors. Last, but not least, the removable and reusable dual size (joint) spacer "DOUBLE", available in two versions, each one designed to create two joints of different sizes (one model for joints of 1 and 3 mm - 1/32" and 1/8", one model for joints 2 and 5 mm - 3/32" and 3/16"). Designed to work on the sides of the tiles and flush to the floor as well as into corners. This is particularly helpful for wall covering.

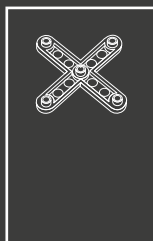

REMOVABLE AND REUSABLE DUAL SIZE (JOINT) SPACER

MADE IN ITALY



282D1-3C300
Rear view (flat facet)



282D1-3C300
Front view

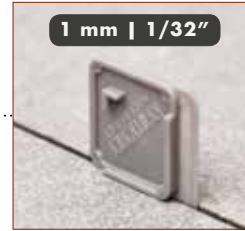

1 mm | 1/32"

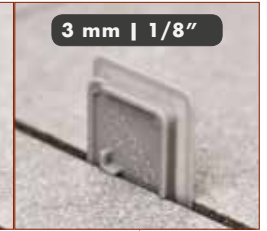

3 mm | 1/8"



282D2-5C300
Rear view (flat facet)



282D2-5C300
Front view



2 mm | 3/32"



5 mm | 3/16"

- Available in two versions: to create joint sized 1 and 3 mm - 1/32" and 1/8" (grey color); to create joints sized 2 and 5 mm - 3/32" and 3/16" (red color).
- Each DOUBLE is designed to create two joints of different sizes: two sides for one joint size, the other two for the other joint size. Therefore, DOUBLE is actually a "Dual-Size" removable (and reusable) spacer.
- The dual size (joint) spacer DOUBLE has been de-signed to be very easy to remove after use. This in accordance with regulations about correct ceramic tile installation such as the Italian UNI 11493-1.
- The removal and use do not damage the product therefore DOUBLE is reusable virtually forever.
- Its generous dimensions (37x37 mm | 1 1/2"x1 1/2") make very easy to grasp it both during insertion and, even more important, removal phase.
- The wide gap within joints sizes present on the same spacer makes it easy to recognize them.

- Thanks to the wide contact surface between tiles once in working position, DOUBLE ensures both perfect joint size and parallelism of the tiles.
- DOUBLE is designed to work on the sides of the tiles (not into intersections) so to ensure the maximum effectiveness (especially on large format tiles).
- One of the two facets of DOUBLE is flat so to allow the product to be used flush to the floor as well as into corners. This is particularly helpful for wall covering.
- DOUBLE is made of plastic material which hinders the adhesion of the adhesive (thin-set) to the spacer.
- Double is proposed inside a practical resealable bucket for storing the product after use.

DOUBLE 1-3 mm (1/32" - 1/8") and 2-5 mm (3/32" - 3/16")

Part No.			Description	Joint	Color		
282D1-3C300	8050532000636	6	DOUBLE SPACER; joint 1 and 3 mm (1/32" - 1/8"). 300 pcs bucket.	1 e 3 mm 1/32" e 1/8"		58x20xh 27 cm 23"x8"x h 10 1/2"	5,5 Kg 12.1 lbs
282D2-5C300	8050532002432	6	DOUBLE SPACER; joint 2 and 5 mm (3/32" - 3/16"). 300 pcs bucket.	2 e 5 mm 3/32" e 3/16"			6,9 Kg 15.2 lbs

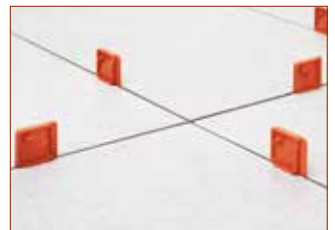

SPACERS FOR 20 mm (3/4") THICKNESS TILES – JOINT 4 mm (5/32")

MADE IN ITALY

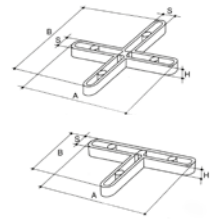
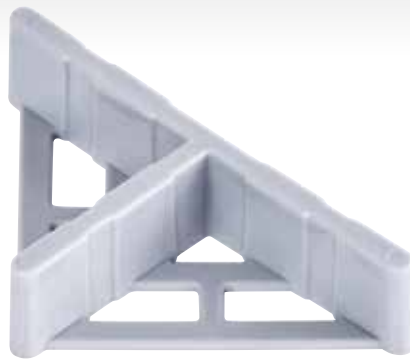

313+200		313+500	
S	A	B	H
4mm 5/32"	64mm 2 1/2"	64mm 2 1/2"	12mm 15/32"

313T200		313T500	
S	A	B	H
4mm 5/32"	64mm 2 1/2"	34mm 1 11/32"	12mm 15/32"

- Spacers for tiles/slabs with a thickness equal or higher than 20 mm (3/4").
- Available both "+" and "T" types.
- Perfect for outdoor floors laid both with adhesive or onto sand.
- Made of plastic material which is tested for being resistant even when subjected to bad weather conditions and thermal stress.

- Equipped with special wings, designed for preventing the rising of the spacer during the vibrator method.
- The special wings are also provided with specific openings with draining function.
- Spacer's height: 12 mm (1/2").

Part No.	Barcode	Type	Pieces	Box	Box	Box	Box	Box	Box	Box	Box	Box	Box	Box	Box	Box	Box
313+200	8024648095268	+	200	-	•	-	•	-	•	•	8	59x30xh40 cm 23 5/8"x11 7/8"xh 15 5/4"	9,7 Kg	21.4 lbs			
313+500	8024648095275	+	500	-	•	-	•	-	•	3	9,2 Kg		20.3 lbs				
313T200	8024648095282	T	200	-	•	-	•	-	•	12	11 Kg		24.3 lbs				
313T500	8024648095299	T	500	-	•	-	•	-	•	5	11,4 Kg		25.1 lbs				

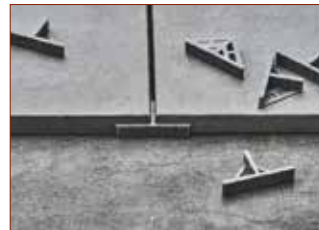
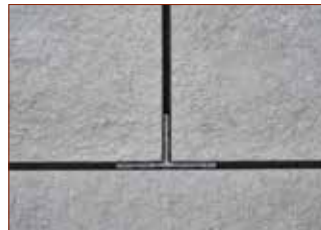
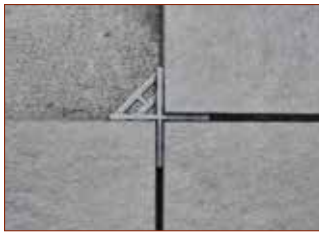

ROTOCUNEO - FROM 2 mm (3/32") UP TO 10 mm (3/8") JOINTS

MADE IN E.U.



- 3 in 1 tile shim: 2 spiral-shaped wedges (lateral ones) + 1 wedge (middle one).
- For joint adjustments from 2 to 10 mm.

- In the removal phase, it avoids the chipping of the tile / slab.
- Recommended for extremely delicate tiles / slabs.

Part No.	Barcode	Box	Description	Joint	Weight	Weight	Box	Box	Weight	Weight
162RC30	8050532006775	27	30 Kits Rotocono bucket (60 spiral-shaped wedges + 30 wedges)	da 2 a 10 mm da 3/32" a 3/8"	220 gr	0.5 oz	40x60xh 25 cm	15 3/4"x23 5/8"xh 10"	7 Kg	15.4 oz

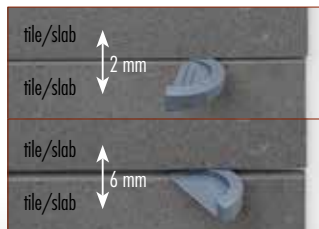
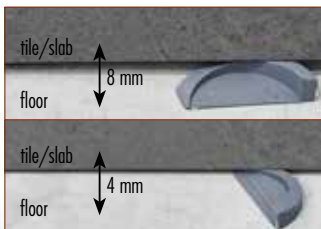

SPACERS 10 mm – 3/8"

MADE IN ITALY



193+1000		204+200	
S	A	B	H
10mm	40mm	40mm	7mm
3/8"	1 9/16"	1 9/16"	9/32"



204 R200			
S	A	B	H
10mm	50mm	50mm	13mm
3/8"	2"	2"	17/32"



193T1000		204T200	
S	A	B	H
10mm	40mm	25mm	7mm
3/8"	1 9/16"	1"	9/32"



204T200A			
S	A	B	H
10mm	50mm	30mm	13mm
3/8"	2"	1 3/16"	17/32"

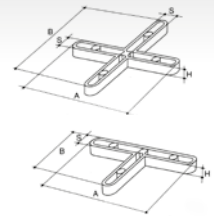

Part No.	Barcode	Type	Pieces	Box	Bag	Upright	Arch	Down	Up	Down	Up	Box	Box	Weight	
193+1000	8024648001306	+	1000	•	-	•	-	-	•	-	-	12	62x42x54 cm	24 3/8"x16 1/2"xh 21 1/4"	26,5 Kg 58.4 lbs
204+200	8024648001641	+	200	-	•	•	-	-	•	-	-	25	48x46x28 cm	18 7/8"x18 1/8"xh 11"	10,6 Kg 23.3 lbs
204R200	8024648001634	+	200	-	•	-	-	-	-	-	-	10	48x46x28 cm	18 7/8"x18 1/8"xh 11"	9,2 Kg 20.3 lbs
193T1000	8024648001313	+	1000	•	-	•	-	-	•	-	-	12	62x42x54 cm	24 3/8"x16 1/2"xh 21 1/4"	20,2 Kg 44.5 lbs
204T200	8024648001658	+	200	-	•	•	-	-	•	-	-	25	48x35x28 cm	18 7/8"x13 3/4"xh 11"	7,4 Kg 16.3 lbs
204T200A	8024648001665	+	200	-	•	-	-	-	•	-	-	10	48x35x28 cm	18 7/8"x13 3/4"xh 11"	6,6 Kg 14.5 lbs

SPACERS 9 mm – 11/32"



129+1000		128+200	
S	A	B	H
9mm	50mm	50mm	7mm
11/32"	2"	2"	9/32"



129T1000		128T200	
S	A	B	H
9mm	50mm	30mm	7mm
11/32"	2"	1 3/16"	9/32"

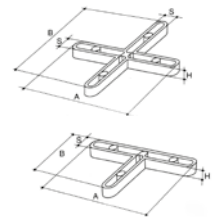

Part No.	Barcode	Type	Pieces	Box	Bag	Upright	Arch	Down	Up	Down	Up	Box	Box	Weight	
129+1000	8024648001337	+	1000	•	-	-	•	•	-	-	-	12	62x42x54 cm	24 3/8"x16 1/2"xh 21 1/4"	32,2 Kg 70.9 lbs
128+200	8024648001672	+	200	-	•	-	•	•	-	-	-	25	48x46x28 cm	18 7/8"x18 1/8"xh 11"	13,6 Kg 29.9 lbs
129T1000	8024648001344	+	1000	•	-	-	•	•	-	-	-	12	62x42x54 cm	24 3/8"x16 1/2"xh 21 1/4"	26,7 Kg 58.8 lbs
128T200	8024648001689	+	200	-	•	-	•	•	-	-	-	25	48x35x28 cm	18 7/8"x13 3/4"xh 11"	10,6 Kg 23.3 lbs

SPACERS 8 mm – 5/16"



372+1000		376+200	
S	A	B	H
8mm	40mm	40mm	7mm
5/16"	1 9/16"	1 9/16"	9/32"



372T1000		376T200	
S	A	B	H
8mm	40mm	25mm	7mm
5/16"	1 9/16"	1"	9/32"

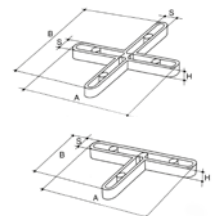

Part No.	Barcode	Type	Pieces	Box	Bag	Upright	Arch	Down	Up	Down	Up	Box	Box	Weight	
372+1000	8024648001351	+	1000	•	-	•	-	-	•	-	-	12	62x42x54 cm	24 3/8"x16 1/2"xh 21 1/4"	23,1 Kg 50.9 lbs
376+200	8024648001696	+	200	-	•	•	-	-	•	-	-	25	48x46x28 cm	18 7/8"x18 1/8"xh 11"	9,6 Kg 21.2 lbs
372T1000	8024648001368	+	1000	•	-	•	-	-	•	-	-	8	46x41x32 cm	18 1/8"x16 1/8"xh 12 5/8"	12,7 Kg 27.9 lbs
376T200	8024648001702	+	200	-	•	•	-	-	•	-	-	25	48x35x28 cm	18 7/8"x13 3/4"xh 11"	7,6 Kg 16.7 lbs

SPACERS 7 mm – 9/32"



152+1000E		151+200E	
S	A	B	H
7mm	40mm	40mm	7mm
9/32"	1 9/16"	1 9/16"	9/32"



152+1000L		151+200L	
S	A	B	H
7mm	40mm	40mm	5mm
9/32"	1 9/16"	1 9/16"	3/16"



152T1000E		151T200E	
S	A	B	H
7mm	40mm	25mm	7mm
9/32"	1 9/16"	1"	9/32"

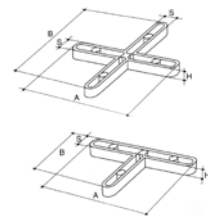

Part No.	Barcode	Type	Pieces	Box	Bag	Upright	Arch	Down	Up	Down	Up	Box	Box	Weight	
152+1000E	8024648001375	+	1000	•	-	•	-	-	•	-	-	12	62x42x54 cm	24 3/8"x16 1/2"xh 21 1/4"	26 Kg 57.3 lbs
151+200E	8024648001719	+	200	-	•	•	-	-	•	-	-	25	48x46x28 cm	18 7/8"x18 1/8"xh 11"	10,6 Kg 23.4 lbs
152+1000L	8024648001382	+	1000	•	-	•	-	-	•	-	-	16	62x42x45 cm	24 3/8"x16 1/2"xh 21 1/4"	18,4 Kg 40.5 lbs
151+200L	8024648001726	+	200	-	•	•	-	-	•	-	-	25	48x35x28 cm	18 7/8"x13 3/4"xh 11"	5,6 Kg 12.3 lbs
152T1000E	8024648001399	+	1000	•	-	•	-	-	•	-	-	8	46x41x32 cm	18 1/8"x16 1/8"xh 12 5/8"	13,3 Kg 29.3 lbs
151T200E	8024648001733	+	200	-	•	•	-	-	•	-	-	30	48x35x28 cm	18 7/8"x13 3/4"xh 11"	9,6 Kg 21.2 lbs



SPACERS 6 mm – 1/4"

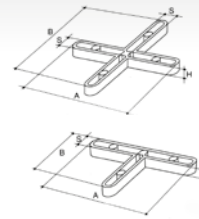

MADE IN ITALY

154+1000		153+200	
S	A	B	H
6mm	50mm	50mm	7mm
1/4"	2"	2"	9/32"

154+200		153T200	
S	A	B	H
6mm	50mm	28mm	7mm
1/4"	2"	1 7/64"	9/32"

Part No.	Barcode	Type	Pieces	Box	Envelope	U-bolt	Washer	Arrow	Stop	Up Arrow	Box	Box	Box		
154+1000	8024648001405	+	1000	•	-	-	•	•	-	-	12	62x42xh 54 cm	24 3/8"x16 1/2"xh 21 1/4"	18,8 Kg	41.4 lbs
153+200	8024648001740	+	200	-	•	-	•	•	-	-	25	48x46xh 28 cm	18 7/8"x18 1/8"xh 11"	8,13 Kg	17.9 lbs
154T1000	8024648001412	+	1000	•	-	-	•	•	-	-	8	46x41xh 32 cm	18 1/8"x16 1/8"xh 12 5/8"	10,9 Kg	24 lbs
153T200	8024648001757	+	200	-	•	-	•	•	-	-	30	48x35xh 28 cm	18 7/8"x13 3/4"xh 11"	8,1 Kg	17.8 lbs

SPACERS 5 mm – 3/16"

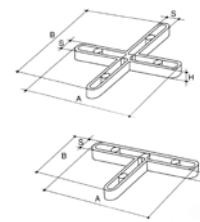

156+1000		155+200	
S	A	B	H
5mm	50mm	50mm	6mm
3/16"	2"	2"	1/4"

156+1000L		155+200L	
S	A	B	H
5mm	40mm	40mm	5mm
3/16"	1 9/16"	1 9/16"	3/16"

156R1000S		155R200	
S	A	B	H
5mm	50mm	50mm	6mm
3/16"	2"	2"	9/32"

156T1000		155T200	
S	A	B	H
5mm	35mm	28mm	6mm
3/16"	1 3/8"	1 7/64"	1/4"

156T1000E		155T200E	
S	A	B	H
5mm	35mm	28mm	6mm
3/16"	1 3/8"	1 7/64"	1/4"

Part No.	Barcode	Type	Pieces	Box	Envelope	U-bolt	Washer	Arrow	Stop	Up Arrow	Box	Box	Box		
156+1000	8024648001450	+	1000	•	-	-	•	•	-	-	12	62x42xh 54 cm	24 3/8"x16 1/2"xh 21 1/4"	15 Kg	33 lbs
155+200	8024648001795	+	200	-	•	-	•	•	-	-	25	48x46xh 28 cm	18 7/8"x18 1/8"xh 11"	5,6 Kg	12.4 lbs
156+1000L	8024648001436	+	1000	•	-	-	•	•	-	-	16	62x42xh 45 cm	24 3/8"x16 1/2"xh 17 3/4"	16,8 Kg	37 lbs
155+200L	8024648001771	+	200	-	•	-	•	•	-	-	25	48x35xh 28 cm	18 7/8"x13 3/4"xh 11"	5,6 Kg	12.4 lbs
156R1000S	8024648008329	+	1000	•	-	-	•	•	-	-	10	62x42xh 45 cm	24 3/8"x16 1/2"xh 17 3/4"	13,8 Kg	30.4 lbs
155R200	8024648001764	+	200	-	•	-	•	•	-	-	20	48x46xh 28 cm	18 7/8"x18 1/8"xh 11"	6,6 Kg	14.5 lbs
156T1000	8024648001467	+	1000	•	-	-	•	•	-	-	8	46x41xh 32 cm	18 1/8"x16 1/8"xh 12 5/8"	8,1 Kg	17.8 lbs
155T200	8024648001801	+	200	-	•	-	•	•	-	-	30	48x35xh 28 cm	18 7/8"x13 3/4"xh 11"	6 Kg	13.2 lbs
156T1000E	8024648001443	+	1000	•	-	-	•	•	-	-	16	46x41xh 32 cm	18 1/8"x16 1/8"xh 12 5/8"	14,1 Kg	31 lbs
155T200E	8024648001788	+	200	-	•	-	•	•	-	-	40	32x32xh 28 cm	12 9/16"x12 9/16"xh 11"	6,8 Kg	15 lbs

SPACERS 4 mm – 5/32"

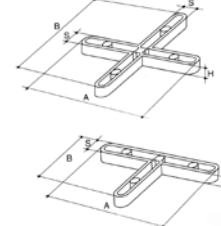

158+1000		157+200	
S	A	B	H
4mm	38mm	38mm	4mm
5/32"	1 31/64"	1 31/64"	5/32"

158R1000		157R200	
S	A	B	H
4mm	30mm	30mm	6mm
5/32"	1 3/16"	1 3/16"	1/4"

158T1000		157T200	
S	A	B	H
4mm	38mm	20mm	4mm
5/32"	1 31/64"	25/32"	5/32"

Part No.	Barcode	Type	Pieces	Box	Envelope	U-bolt	Washer	Arrow	Stop	Up Arrow	Box	Box	Box		
158+1000	8024648001481	+	1000	•	-	-	•	•	-	-	24	62x42xh 45 cm	24 3/8"x16 1/2"xh 17 3/4"	20,7 Kg	45.5 lbs
157+200	8024648001825	+	200	-	•	-	•	•	-	-	50	48x35xh 28 cm	18 7/8"x13 3/4"xh 11"	8,6 Kg	18.9 lbs
158R1000	8024648008435	+	1000	•	-	-	•	•	-	-	16	62x42xh 45 cm	24 3/8"x16 1/2"xh 17 3/4"	22,4 Kg	49.3 lbs
157R200	8024648001818	+	200	-	•	-	•	•	-	-	25	32x32xh 28 cm	12 9/16"x12 9/16"xh 11"	6,9 Kg	15.2 lbs
158T1000	8024648001498	+	1000	•	-	-	•	•	-	-	16	46x41xh 32 cm	18 1/8"x16 1/8"xh 12 5/8"	10,1 Kg	22.3 lbs
157T200	8024648001832	+	200	-	•	-	•	•	-	-	40	32x32xh 28 cm	12 9/16"x12 9/16"xh 11"	5,2 Kg	11.5 lbs

SPACERS, EXPANSION JOINTS AND PROFILES



SPACERS 3 mm - 1/8"

MADE IN ITALY



160+1000		159+200	
S	A	B	H
3mm	38mm	38mm	3,5mm
1/8"	1 31/64"	1 31/64"	9/64"

160+1000E		159+200E	
S	A	B	H
3mm	28mm	28mm	3mm
1/8"	1 7/64"	1 7/64"	1/8"

160+T1000		159+T200	
S	A	B	H
3mm	38mm	38mm	8mm
1/8"	1 31/64"	1 31/64"	5/16"

160R1000		159R200	
S	A	B	H
3mm	38mm	38mm	3,5mm
1/8"	1 31/64"	1 31/64"	9/64"

160+1000A		159+200A	
S	A	B	H
3mm	38mm	38mm	8mm
1/8"	1 31/64"	1 31/64"	5/16"

160T1000		159T200	
S	A	B	H
3mm	38mm	20mm	3,5mm
1/8"	1 31/64"	25/32"	9/32"

Part No.	Barcode	Type	Pieces												
160+1000	8024648001528	+	1000	•	-	•	-	-	•	-	24	62x42x45 cm	24 3/8"x16 1/2"x17 3/4"	17,6 Kg	38.8 lbs
159+200	8024648001863	+	200	-	•	•	-	-	•	-	50	48x35x28 cm	18 7/8"x13 3/4"x11"	6,6 Kg	14.5 lbs
160+1000E	8024648001542	+	1000	•	-	•	-	-	•	-	32	42x42x40 cm	16 1/2"x16 1/2"x15 3/4"	14 Kg	30.9 lbs
159+200E	8024648001887	+	200	-	•	•	-	-	•	-	60	32x32x28 cm	12 9/16"x12 9/16"x11"	4,9 Kg	10.8 lbs
160+T1000	8024648008831	+	1000	•	-	•	-	-	•	-	16	62x42x45 cm	24 3/8"x16 1/2"x17 3/4"	19,6 Kg	43.2 lbs
159+T200	8024648008534	+	200	-	•	•	-	-	•	-	30	48x35x28 cm	18 7/8"x13 3/4"x11"	6,6 Kg	14.5 lbs
160R1000	8024648008572	+	1000	•	-	•	-	-	•	•	16	62x42x45 cm	24 3/8"x16 1/2"x17 3/4"	14,3 Kg	31.5 lbs
159R200	8024648001856	+	200	-	•	•	-	-	•	•	40	48x35x28 cm	18 7/8"x13 3/4"x11"	6,6 Kg	14.5 lbs
160+1000A	8024648005960	+	1000	-	•	•	-	-	•	•	16	62x42x45 cm	24 3/8"x16 1/2"x17 3/4"	18,8 Kg	41.4 lbs
159+200A	8024648005977	+	200	-	•	•	-	-	•	•	30	48x35x28 cm	18 7/8"x13 3/4"x11"	7,5 Kg	16.5 lbs
160T1000	8024648001535	+	1000	•	-	•	-	-	•	-	16	46x41x32 cm	18 1/8"x16 1/8"x12 5/8"	8,5 Kg	18.7 lbs
159T200	8024648001870	+	200	-	•	•	-	-	•	-	40	32x32x28 cm	12 9/16"x12 9/16"x11"	4 Kg	8.8 lbs

SPACERS 2 mm - 3/32"



133+1000		132+200	
S	A	B	H
2mm	28mm	28mm	2,8mm
3/32"	1 7/64"	1 7/64"	7/64"

133+1000A		132+200A	
S	A	B	H
2mm	28mm	28mm	7mm
3/32"	1 7/64"	1 7/64"	9/32"

133R1000		132R200	
S	A	B	H
2mm	28mm	28mm	2,8mm
3/32"	1 7/64"	1 7/64"	7/64"

133R1000A		132R200A	
S	A	B	H
2mm	28mm	28mm	7mm
3/32"	1 7/64"	1 7/64"	9/32"

133T1000		132T200	
S	A	B	H
2mm	28mm	16mm	2,8mm
3/32"	1 7/64"	5/8"	7/64"



132T200AL		133T1000AL	
S	A	B	H
2mm	38mm	20mm	7mm
3/32"	1 1/2"	25/32"	9/32"

132T200ALR		133T1000ALR	
S	A	B	H
2mm	38mm	20mm	7mm
3/32"	1 1/2"	25/32"	9/32"

Part No.	Barcode	Type	Pieces												
133+1000	8024648001566	+	1000	•	-	-	•	-	•	-	32	42x42x40 cm	16 1/2"x16 1/2"x15 3/4"	11,2 Kg	24.7 lbs
132+200	8024648001900	+	200	-	•	•	-	-	•	-	50	32x32x28 cm	12 9/16"x12 9/16"x11"	3,4 Kg	7.5 lbs
133+1000A	8024648008749	+	1000	-	•	•	-	-	•	-	16	46x41x32 cm	18 1/8"x16 1/8"x12 5/8"	11,4 Kg	25 lbs
132+200A	8024648004604	+	200	-	•	•	-	-	•	-	30	32x32x28 cm	12 9/16"x12 9/16"x11"	4,2 Kg	9.3 lbs
133R1000	8024648008671	+	1000	•	-	-	•	-	•	•	16	62x42x45 cm	24 3/8"x16 1/2"x17 3/4"	8,1 Kg	17.8 lbs
132R200	8024648001894	+	200	-	•	•	-	-	•	•	40	32x32x28 cm	12 9/16"x12 9/16"x11"	15,6 Kg	34.4 lbs
133R1000A	8024648014030	+	1000	•	-	-	•	-	•	•	16	62x42x45 cm	24 3/8"x16 1/2"x17 3/4"	11,2 Kg	24.6 lbs
132R200A	8024648015365	+	200	-	•	•	-	-	•	•	30	32x32x28 cm	12 9/16"x12 9/16"x11"	4,5 Kg	9.8 lbs
133T1000	8024648001573	+	1000	•	-	-	•	-	•	-	32	42x42x40 cm	16 1/2"x16 1/2"x15 3/4"	8,9 Kg	19.6 lbs
132T200	8024648001917	+	200	-	•	•	-	-	•	-	50	32x32x28 cm	12 9/16"x12 9/16"x11"	2,4 Kg	5.3 lbs
132T200A	8024648004611	+	200	-	•	•	-	-	•	-	40	32x32x28 cm	12 9/16"x12 9/16"x11"	2,4 Kg	5.3 lbs
132T200AL	8050532008816	+	200	-	•	•	-	-	•	-	30	32x32x28 cm	12 9/16"x12 9/16"x11"	5,1 Kg	11.2 lbs
133T1000AL	8050532008823	+	1000	-	•	•	-	-	•	-	16	46x41x32 cm	18 1/8"x16 1/8"x12 5/8"	11,8 Kg	26 lbs
132T200ALR	8050532008977	+	200	-	•	•	-	-	•	•	30	32x32x28 cm	12 9/16"x12 9/16"x11"	5,2 Kg	11.5 lbs
133T1000ALR	8050532008984	+	1000	•	-	-	•	-	•	•	16	46x41x32 cm	18 1/8"x16 1/8"x12 5/8"	12,4 Kg	27.3 lbs

SPACERS 1,5 mm - 1/16"



131+1000		131+200	
S	A	B	H
1,5mm	33mm	33mm	5mm
1/16"	1 5/16"	1 5/16"	3/16"

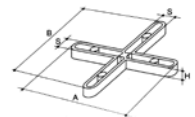

Part No.	Barcode	Type	Pieces												
131+1000	8024648060808	+	1000	•	-	-	•	-	•	-	16	62x42x45 cm	24 1/2"x16 1/2"x17 3/4"	8 Kg	17.6 lbs
131+200	8024648060815	+	200	-	•	•	-	-	•	-	30	46x41x32 cm	18 "x16"x12 1/2"	3 Kg	6.6 lbs

SPACERS 1 mm - 1/32"



143+1000		143+200	
S	A	B	H
1mm	28mm	28mm	3mm
1/32"	1 7/64"	1 7/64"	1/8"

143T1000		143T200	
S	A	B	H
1mm	32mm	16mm	4mm
1/32"	1 3/16"	5/8"	5/32"

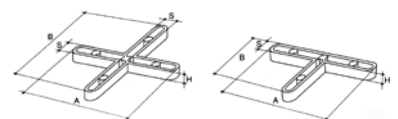

Part No.	Barcode	Type	Pieces												
143+1000	8024648004581	+	1000	•	-	-	•	-	•	-	32	42x42x40 cm	16 1/2"x16 1/2"x15 3/4"	7 Kg	15.4 lbs
143+200	8024648004628	+	200	-	•	•	-	-	•	-	50	32x32x28 cm	12 9/16"x12 9/16"x11"	1,9 Kg	4.2 lbs
143T1000	8024648017796	+	1000	•	-	-	•	-	•	-	32	42x42x40 cm	16 1/2"x16 1/2"x15 3/4"	7 Kg	15.4 lbs
143T200	8024648017802	+	200	-	•	•	-	-	•	-	50	32x32x28 cm	12 9/16"x12 9/16"x11"	1,9 Kg	4.2 lbs





163P1000		162P200	
S	A	B	H
-	28mm 1 7/64"	10mm 13/32"	6mm 1/4"



163G1000		162G200	
S	A	B	H
-	40mm 1 9/16"	9mm 11/32"	8mm 5/16"



MADE IN ITALY

Part No.	Barcode	Type	Pieces	Box	Box	Box	Box	Box	Box	Box	Box	Box	Box	Box	Box
163P1000	8024648001627	▶	1000	•	-	-	•	-	•	-	32	42x42xh40 cm	16 1/2"x16 1/2"xh 15 3/4"	18,2 Kg	40.1 lbs
162P200	8024648001962	▶	200	-	•	-	•	-	•	-	50	32x32xh28 cm	12 9/16"x12 9/16"xh 11"	5,4 Kg	11.9 lbs
163G1000	8024648001610	▶	1000	-	•	-	•	-	•	-	18	62x42xh45 cm	24 3/8"x16 1/2"xh 17 3/4"	20,5 Kg	45.1 lbs
162G200	8024648001955	▶	200	-	•	-	•	-	•	-	25	32x32xh28 cm	12 9/16"x12 9/16"xh 11"	4,2 Kg	9.3 lbs

SPACERS FOR OCTAGONAL TILES, "CASSETTONATO" AND LOZENGE (3 mm - 1/8")



161Y200			
S	A	B	H
3mm 1/8"	22mm 5/8"	28mm 1 1/8"	6mm 1/4"

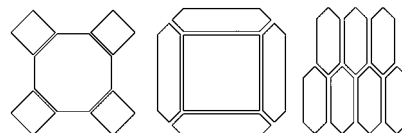
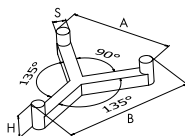

Part No.	Barcode	Type	Pieces	Box	Box	Box	Box	Box	Box	Box	Box	Box	Box	Box	Box
161Y200	8024648001924	Y	200	-	•	-	•	-	•	-	40	32x32xh 28 cm	12 9/16"x12 9/16"xh 11"	3,6 Kg	7.9 lbs

SPACERS FOR HEXAGONAL TILES (3 mm - 1/8")



161E200			
S	A	B	H
3mm 1/8"	34mm 1 11/32"	30mm 1 1/4"	5mm 6/16"

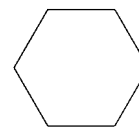
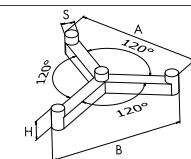

Part No.	Barcode	Type	Pieces	Box	Box	Box	Box	Box	Box	Box	Box	Box	Box	Box	Box
161E200	8024648001931	Y	200	-	•	-	•	-	•	-	40	32x32xh 28 cm	12 9/16"x12 9/16"xh 11"	4,4 Kg	9.7 lbs

SPACERS FOR SPECIAL FORMATS - RHOMBUS - (2 mm - 3/32")



161R200			
S	A	B	H
2mm 3/32"	20mm 25/32"	32mm 1 1/4"	3,5mm 9/64"

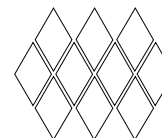
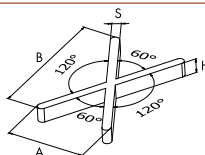

Part No.	Barcode	Type	Pieces	Box	Box	Box	Box	Box	Box	Box	Box	Box	Box	Box	Box
161R200	8050532004184	X	200	-	•	-	•	-	•	-	40	32x32xh 28 cm	12 9/16"x12 9/16"xh 11"	3,7 Kg	8.1 lbs

SPACERS FOR SPECIAL FORMATS - RHOMBUS - (2 mm - 3/32")



161Y200G4			
S	A	B	H
2mm 3/32"	30mm 1 3/16"	34mm 1 1/3"	3,5mm 9/64"

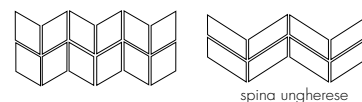
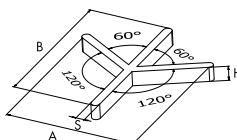

Part No.	Barcode	Type	Pieces	Box	Box	Box	Box	Box	Box	Box	Box	Box	Box	Box	Box
161Y200G4	8050532007093	Y	200	-	•	-	•	-	•	-	40	32x32xh 28 cm	12 9/16"x12 9/16"xh 11"	3,6 Kg	7.9 lbs

SPACERS FOR PROVINCIAL - "PROVENZALE" (3 mm - 1/8")



161P200			
S	A	B	H
3mm 1/8"	-	-	6mm 1/4"



Part No.	Barcode	Type	Pieces	Box	Box	Box	Box	Box	Box	Box	Box	Box	Box	Box	Box
161P200	8024648001948	T	200	-	•	-	•	-	•	-	40	32x32xh 28 cm	12 9/16"x12 9/16"xh 11"	4,4 Kg	9.7 lbs

FLOATING FLOORS SUPPORTS



312P300		
S	O	H
4mm 19/64"	150mm 5 9/16"	6mm 11/16"

Part No.	Barcode	Type	Pieces	Box	Box	Box	Box	Box	Box	Box	Box	Box	Box	Box	Box
312P300	8024648009845	⊙	-	-	-	-	-	-	-	-	300	65x45xh 45 cm	25 9/16"x17 3/4"xh 17 3/4"	27,4 Kg	60.4 lbs



EXPANSION JOINTS AND PROFILES

MADE IN ITALY

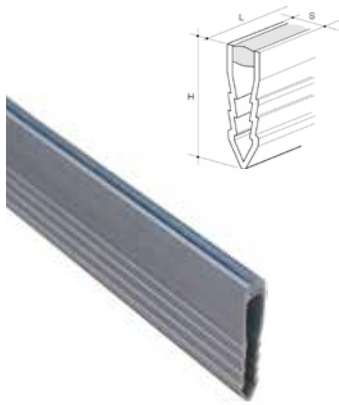

401

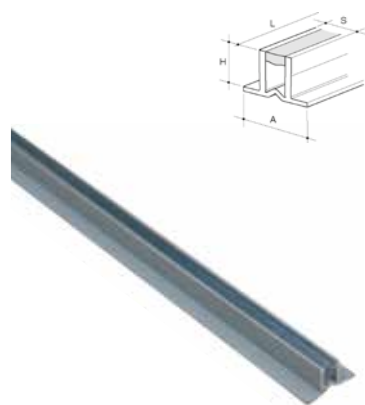

400



404/405/406

PACKAGE



CARTON BOX

EXPANSION JOINTS FOR THIN-SET ADHESIVE

Part No.	Barcode	Carton Qty	Description	COLOR		S	H	Profile Length	Total Qty	Carton Dimensions	Weight
				External	Internal						
400 7X8G	8024648001993	40	Raiflex joint	grey	clear	8 mm 5/16"	7 mm 9/32"	250 cm 8' 2 1/2"	100 m 328'	254x12xh 9 cm 100"x4 3/4"xh 3 1/2"	8,3 Kg 18.3 lbs
400 9X8G	8024648002006	40	Raiflex joint	grey	clear	8 mm 5/16"	9 mm 23/64"	250 cm 8' 2 1/2"	100 m 328'	254x12xh 9 cm 100"x4 3/4"xh 3 1/2"	11,5 Kg 25.3 lbs
400 11X8G	8024648002013	40	Raiflex joint	grey	clear	8 mm 5/16"	11 mm 7/16"	250 cm 8' 2 1/2"	100 m 328'	254x12xh 9 cm 100"x4 3/4"xh 3 1/2"	14,7 Kg 32.4 lbs
400 13X8G	8024648002020	40	Raiflex joint	grey	clear	8 mm 5/16"	13 mm 33/64"	250 cm 8' 2 1/2"	100 m 328'	254x12xh 9 cm 100"x4 3/4"xh 3 1/2"	17,9 Kg 39.4 lbs
400 15X8G	8024648002037	40	Raiflex joint	grey	clear	8 mm 5/16"	15 mm 19/32"	250 cm 8' 2 1/2"	100 m 328'	254x12xh 9 cm 100"x4 3/4"xh 3 1/2"	21,1 Kg 6.5 lbs
400 20X8GG	8024648095732	40	Raiflex joint	light grey	light grey	8 mm 5/16"	19 mm 3/4"	250 cm 8' 2 1/2"	100 m 328'	254x16xh 9 cm 100"x6 1/4"xh 3 1/2"	16 Kg 35.3 lbs

EXPANSION JOINTS FOR MORTAR / MUD

Part No.	Barcode	Carton Qty	Description	COLOR		S	H	Profile Length	Total Qty	Carton Dimensions	Weight
				External	Internal						
401 23X8G	8024648002112	40	Raiflex joint	grey	clear	8 mm 5/16"	25 mm 31/32"	250 cm 8' 2 1/2"	100 m 328'	254x12xh 9 cm 100"x4 3/4"xh 3 1/2"	12,9 Kg 28.4 lbs
401 35X8G	8024648002105	40	Raiflex joint	grey	clear	8 mm 5/16"	35 mm 1 3/8"	250 cm 8' 2 1/2"	100 m 328'	254x16xh 9 cm 100"x6 1/4"xh 3 1/2"	22,5 Kg 49.6 lbs

PVC TRANSITION PROFILES

Part No.	Barcode	Carton Qty	Description	COLOR	H	Profile Length	Total Qty	Carton Dimensions	Weight
404TRIM6B	8024648002303	100	Jolly PVC	white	6 mm	250 cm	250 m	254x13xh 9 cm	13,3 Kg
404TRIM6G	8024648002310	100	Jolly PVC	grey	15/64"	8' 2 1/2"	820' 2 1/2"	100"x5 1/16"xh 3 1/2"	29,3 lbs
405TRIM8B	8024648002334	80	Jolly PVC	white	8 mm	250 cm	200 m	254x13xh 9 cm	13,9 Kg
405TRIM8G	8024648002341	80	Jolly PVC	grey	5/16"	8' 2 1/2"	656' 2"	100"x5 1/16"xh 3 1/2"	30,6 lbs
406TRIM10B	8024648002365	50	Jolly PVC	white	10 mm	250 cm	125 m	254x13xh 9 cm	10,8 Kg
406TRIM10G	8024648002372	50	Jolly PVC	grey	13/32"	8' 2 1/2"	410' 1 1/4"	100"x5 1/16"xh 3 1/2"	23,8 lbs

SPACERS, EXPANSION JOINTS AND PROFILES